

Pole S

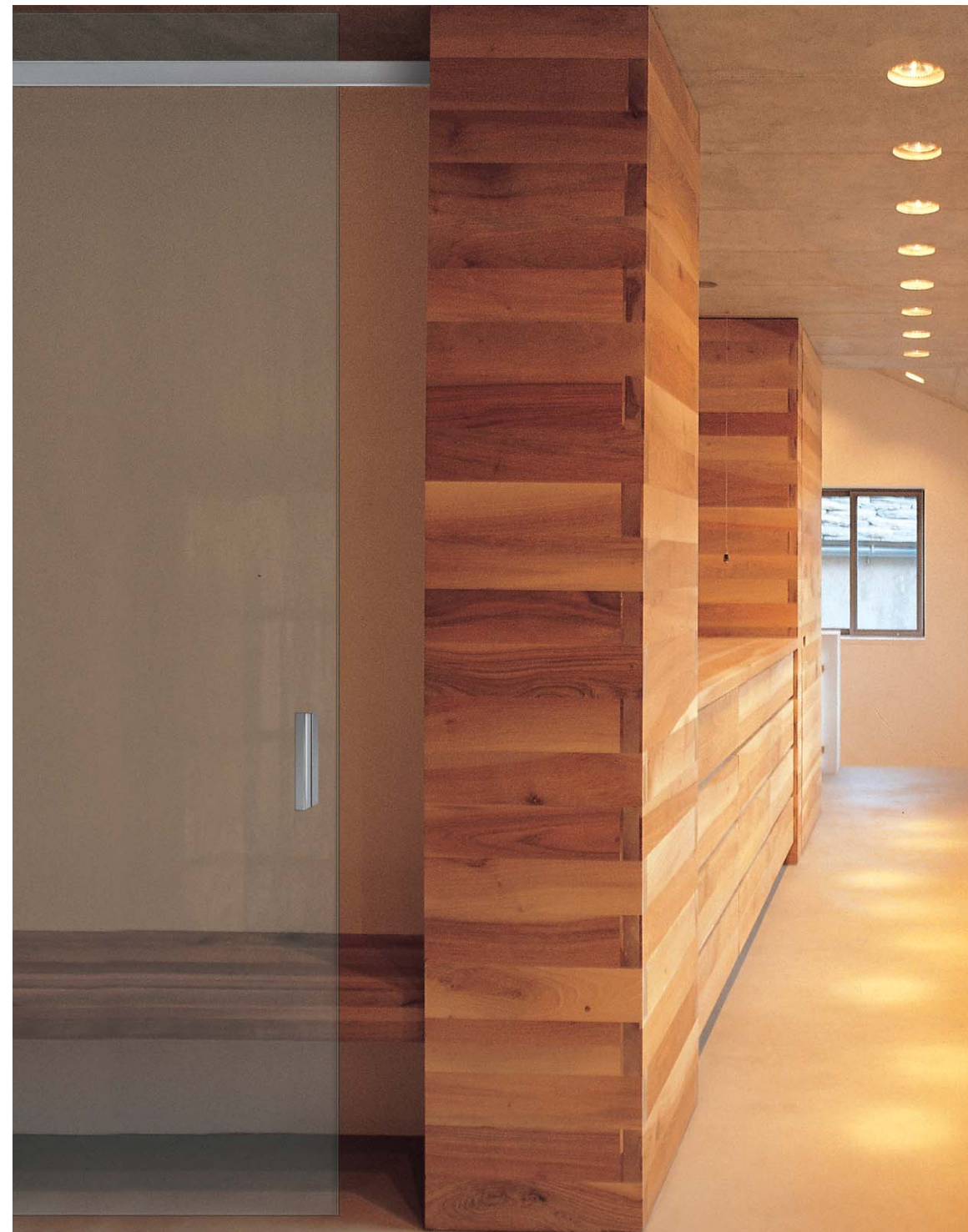



Sistema di porte scorrevoli in cristallo temperato di 8 mm che scorrono su binari in alluminio da fissare a muro. Semplice ed elegante è disponibile nelle versioni ad una o due ante con differenti tipologie di maniglie.

Sliding doors system with 8 mm tempered glass which slide on aluminium tracks to be fixed at wall. Simple and elegant, it is available in the single and double version, with different kinds of handles and locks.

Système de portes coulissantes en verre trempé de 8 mm qui coulissent sur rails en aluminium à fixer au mur. Simple et élégant, il est disponible dans la version à un ou deux panneaux avec différents typologies de poignées et serrures.

Schiebetürensystem mit 8 mm gehärtetem Glas das an einem an der Mauer befestigten Gleis schiebt. Einfach und elegant, es ist in der Einzel und Doppelversion verfügbar mit verschiedenen Arten von Griffen und Schlössern.

Sistema de puertas correderas de cristal templado de 8 mm que se desplazan sobre rieles de aluminio que se fijan en la pared. Sencillo y elegante, está disponible en versiones de una o dos hojas, con diferentes tipos de asas.



Pole S technical info



a. fronte
b. retro
c. particolare struttura

a. front
b. back
c. structure detail

a. recto
b. verso
c. détail de la structure

a. Vorderseite
b. Rückseite
c. Strukturdetail

a. frente
b. trasera
c. particular de l'estructura

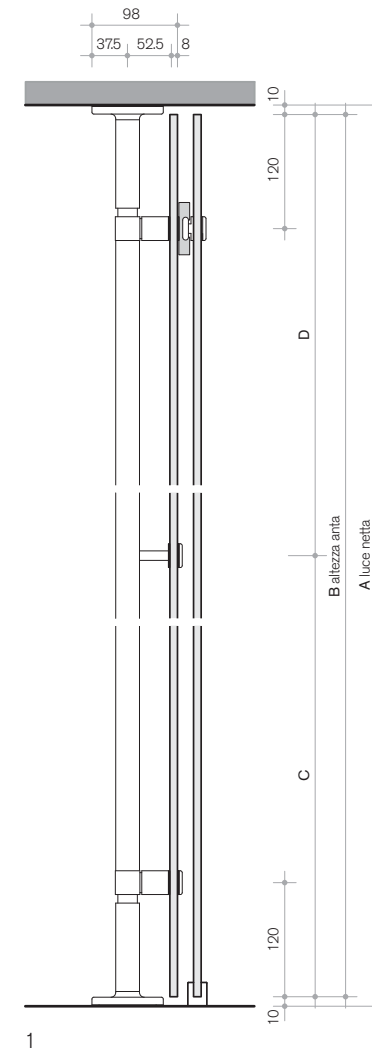

1

1. sezione verticale
2. sezione orizzontale scorrevole su parete Pole
3. sezione orizzontale scorrevole su muro

1. vertical section
2. horizontal section sliding door on Pole wall
3. horizontal section sliding door on wall

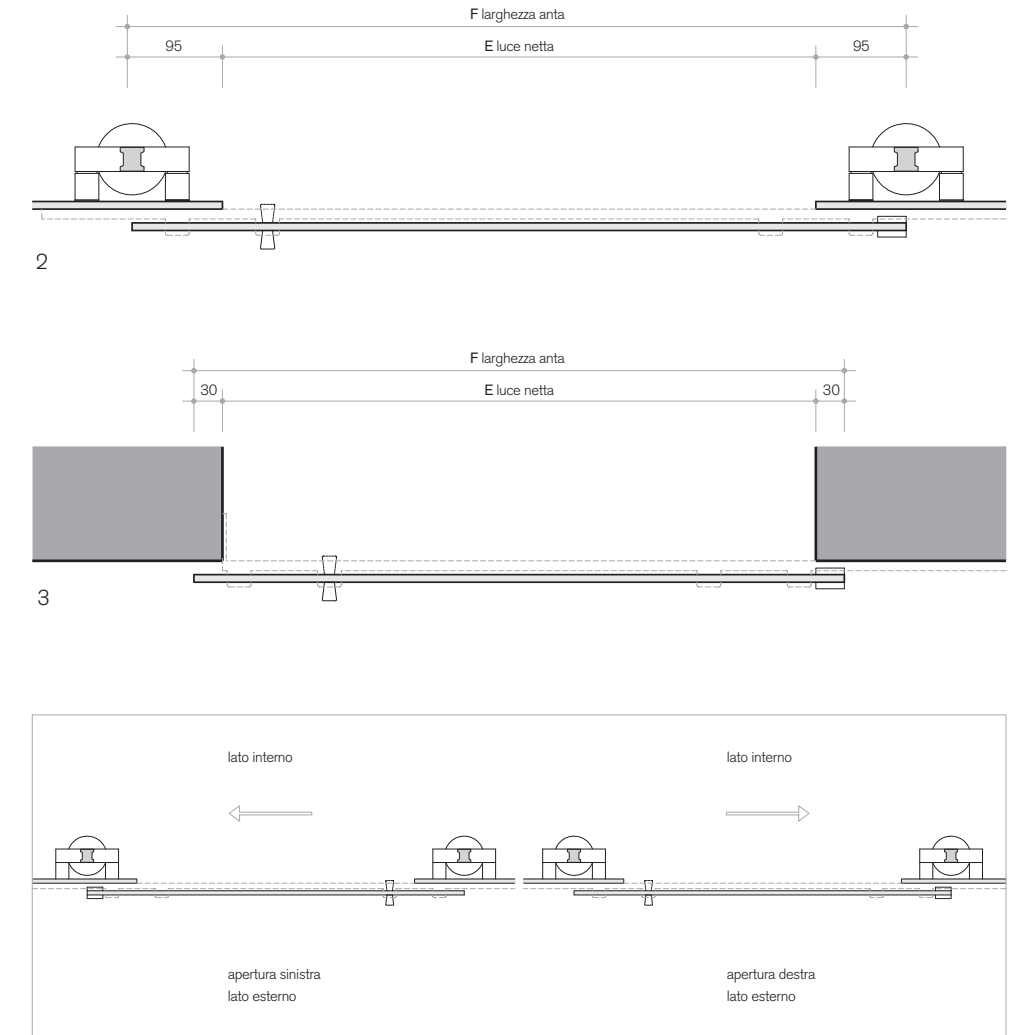

3

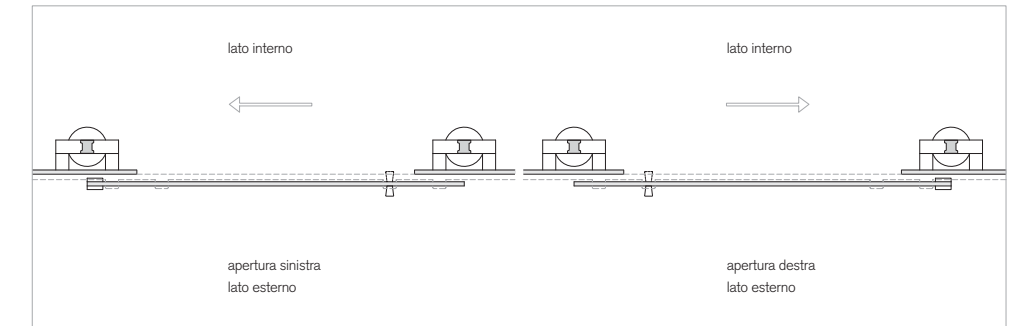

apertura sinistra
lato esterno

apertura destra
lato esterno

1. section verticale
2. section horizontale coulissant sur cloison Pole
3. section horizontale coulissant au mur

1. Vertikalschnitt
2. Querschnitt der Schiebetür an die Pole Wand
3. Querschnitt der Schiebetür an di Wand

1. sección vertical
2. sección horizontal corredera en la pared Pole
3. sección horizontal corredera en la pared

Pole doors **general info**

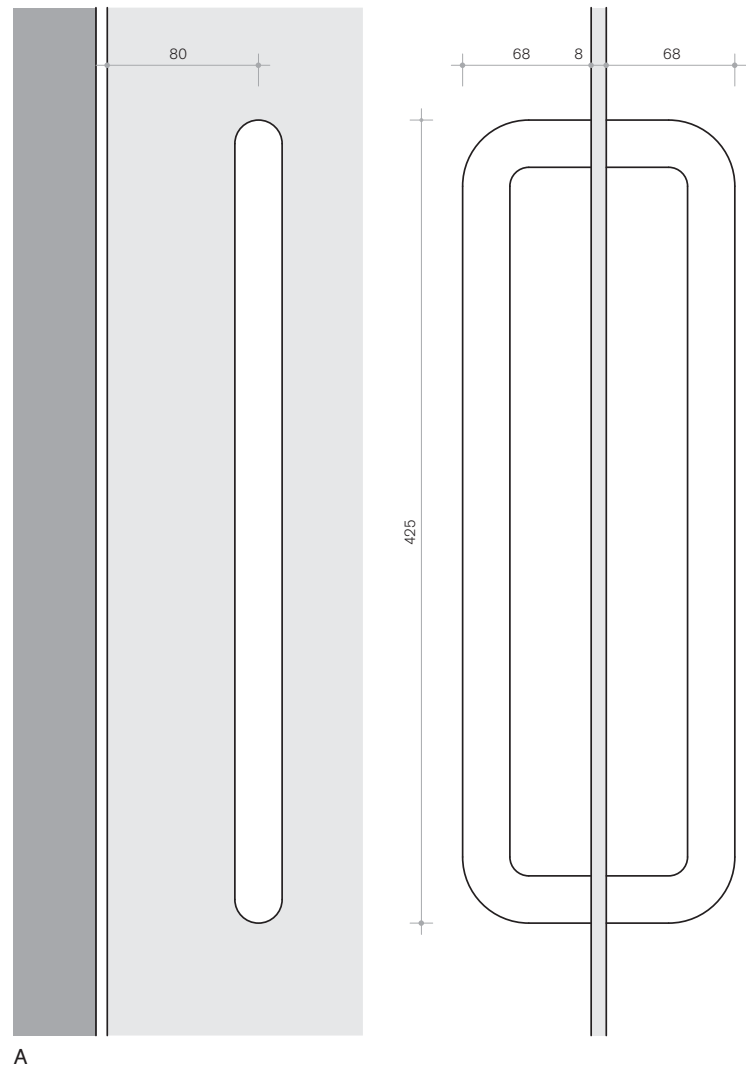

A

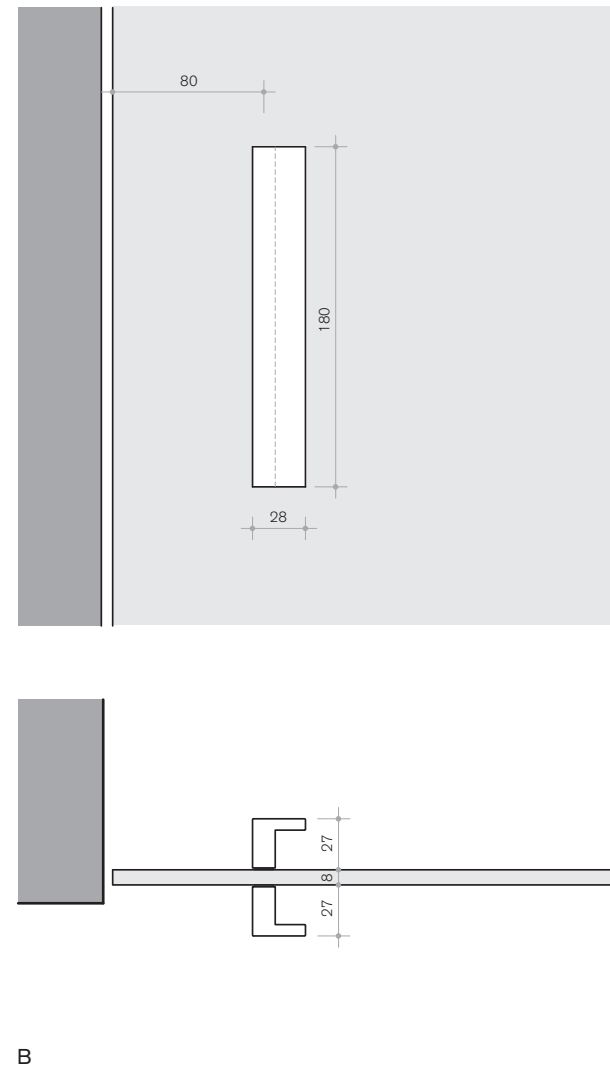

B

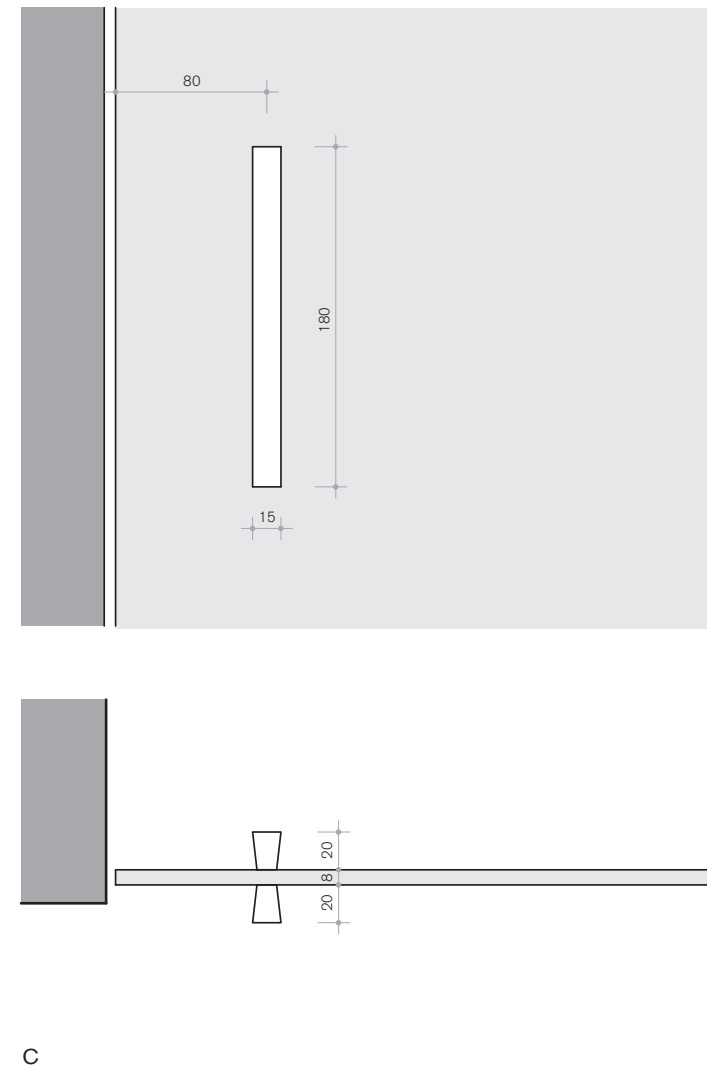

C

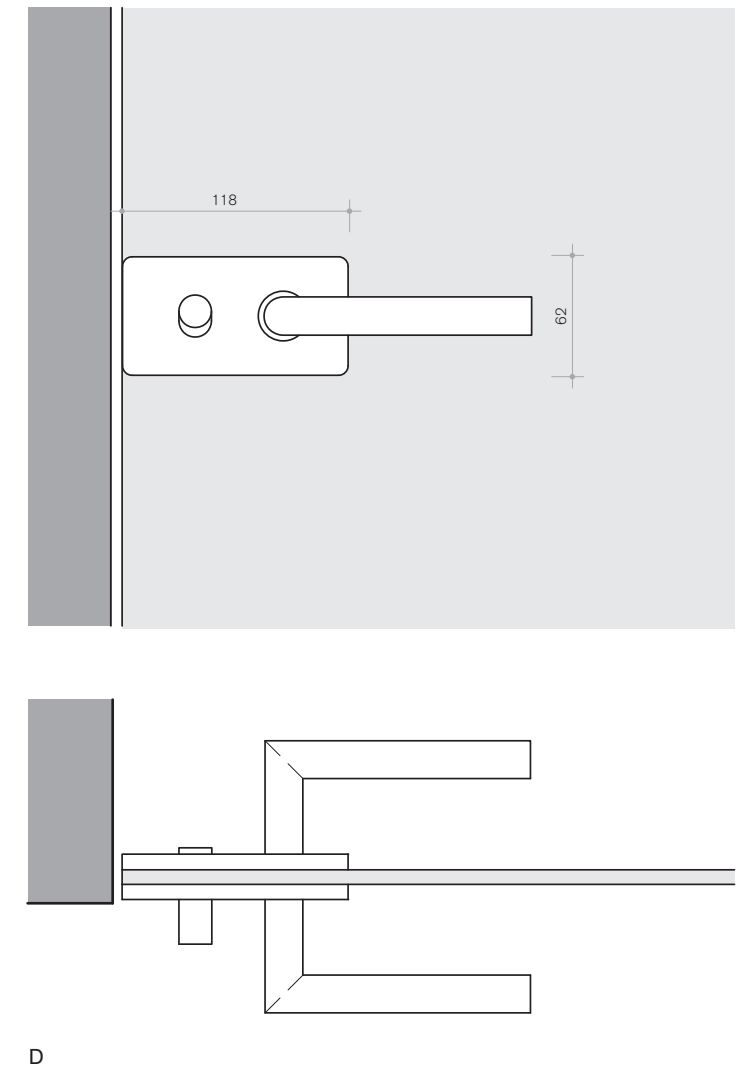

D

A. maniglione doppio
in alluminio anodizzato
B. maniglia a barretta
sezione "L"

A. large double handle
in anodised aluminium
B. L shape handle

A. grande poignée double
en aluminium anodisé
B. poignée en L

A. Großer Doppelgriff aus
eloxierten Aluminium
B. Griff in L-Form

A. manillón doble en
aluminio anodizado
B. manilla en L

C. maniglia a barretta
D. maniglia a leva
con chiavistello

C. bar handle
D. lever handle with latch

C. poignée en forme de barre
D. poignée de levier avec la
serrure

C. Griff in Stab-Form
D. Hebelgriff mit Schloss

C. manilla en forma de barra
D. manilla con el pestillo